



Shielded lamps



- table lamp made from sustainable raw material, beech wood
- waxed dirt-repellent surface, can be cleaned with a damp cloth
- shielded from lamp to mains plug
- Visually, ecologically and naturally designed beech wood lamp with natural coloured shade.

To prevent any evaporation, the inner reflector of the lampshade is made of paper cardboard (not PVC plastic). The surface of the shade is natural cotton (nettle fabric).

The production takes place in Germany. This makes it possible to replace individual parts individual parts, such as the mains connection cable or the lampshade.

Shielding effect in comparison

(Applies to all Biologa Danell lamps):

EAn unshielded luminaire (protection class 2) with an unshielded connecting cable results in an alternating electric field of **100.0 to 160.0 V/m** (building biology recommended guide value 10.0 V/m).

The shielded lamp (protection class 1) with appropriate construction only generates an alternating electric field of a minimum of **0.4 to 0.6 V/m**.

The testing of the shielding is carried out according to the specifications, frequency bands and measuring distances of the recognised screen standards (for low-radiation screens / monitors): TCO'99, Band I (MPR II) and DIN EN 50279 (measuring distance 30 cm).

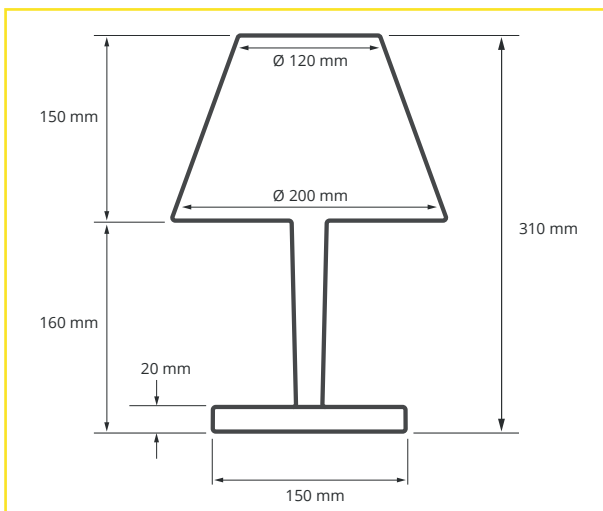

Shielded lamps

Beech wood table lamp LA-TN

Technical data

colour:	beech wood, nature
cable length:	ca. 200 cm white
mains connection shielded:	right-angle earthing contact plug DIN 49441
switch:	2-pole, pull switch in socket
operating voltage:	230 VAC / 50 Hz
dimensions:	see drawing
light source:	E27 max. 33 W (≈ 40 W bulb load)
protection class:	1 (with grounding wire)
shielding alternating electric field:	shielded mains cable (aluminium tape, two-wire, shielding basket)
shielding basket:	spiral stainless steel with screw ring E27
shielding alternating magnetic field:	cable lay 10 (individual wires twisted together ten times per metre)
test according to:	TCO'99 (MPR II, DIN EN 50279) limits undercut by a factor of 20 and more for all measurement methods, undercut by a factor of 20 and more, individually by 100

Scope of delivery

- lamp with two illuminants G9 - 33 W and shade basket
- operating instructions



Order-no.: 400048 - 41-6485
Short-desc.: LA-TN



Shielded lamps and connection cables

A step towards healthier living and working

■ Why shielding against electric and magnetic fields?

Electric and magnetic fields occur everywhere. Their causes are both natural and artificial. Artificially generated fields in particular are becoming increasingly important.

The use of electrical and electronic devices in the living and working environment is constantly increasing.

The influence of artificially generated fields on the human organism has not yet been conclusively researched, but there is increasing note that people react sensitively to exposure to electric and/or magnetic fields.

Electric fields are basically caused by every electric line, even if a connected device is not switched on. This field can be almost completely eliminated by using shielded components, without having to sacrifice comfort.

Magnetic fields only occur when a device / lamp is also switched on and thus a current flows. Magnetic fields can also be significantly reduced by the appropriate design of a lamp.

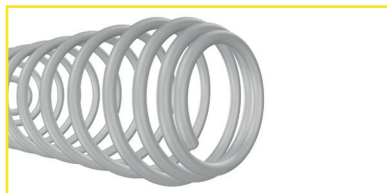
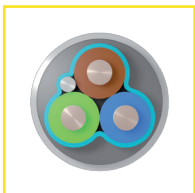

■ Practical construction of shielded lamps

Our shielded lamps basically consist of a three-pole connecting cable, a metal lamp housing of protection class I and a shielding basket for the light source.

While conventional mains cables are usually designed with two poles and a Euro plug, our cables have three poles (with protective conductor, increased safety) and are equipped with a metallic sheathing of the cores as a shield.

Our lamps have a metallic housing (or inner housing in the case of lamps made of wood) which, unlike other materials such as plastic or wood, also shields against the alternating electric field.

Lamp socket and light source (according to building biology recommendations) were integrated into the shielded system by means of a shielding basket, as considerable alternating electric fields can be measured here as well without shielding.

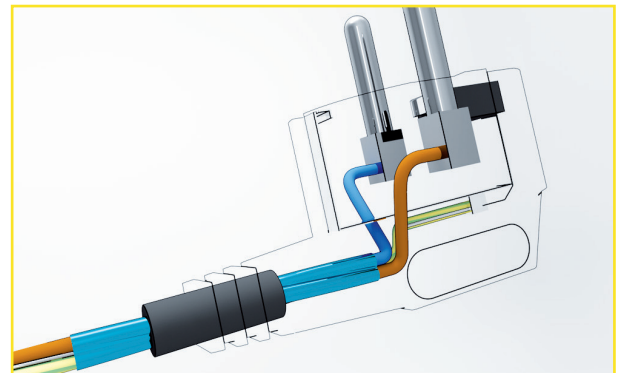

Shielding effect in comparison

An unshielded lamp (protection class 2) with an unshielded connecting cable produces an alternating electric field of 100.0 to 160.0 V/m (building biology recommended guide value 10.0 V/m). The shielded lamp (protection class 1) with a corresponding construction only produces an alternating electric field of a minimum of 0.4 to 0.6 V/m.

The screening is checked according to the specifications, frequency bands and measuring distances of the recognised screen standards (for low-radiation screens / monitors): TCO'99, Band I (MPR II) and DIN EN 50279 (measuring distance 30 cm)..

What else can be done?

- Only use shielded connection cables and socket strips for your other devices!
- Never leave appliances switched on or in stand-by mode for longer than necessary; always unplug the appropriate mains plug or switch off two-pole.
- Avoid electrical appliances in your bedrooms or living rooms or place them as far away from you as possible.

Generally useful notes on the subject of „electrosmog“ can be found on the Internet at:

www.verband-baubiologie.de

www.baubiologie.net

www.baubiologie.de

All product information on shielded cables, connecting cables, socket strips and lamp systems can be found under: www.biologadanell.com.



Beech Wood Table Lamp - Instruction Manual

LA-TN nature - 41-6485 - 400048

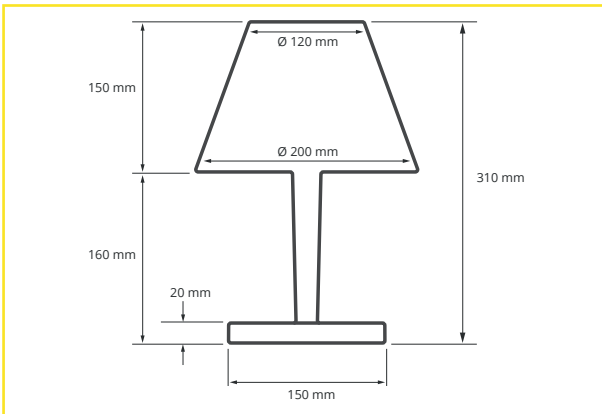

Safety instructions

All electrical work (work on electrical equipment and installations) must be carried out and inspected by a qualified electrician or under their direction and supervision!

Use your lamp only in normally tempered, dry indoor rooms. No outdoor use!

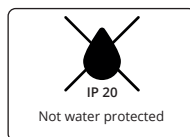
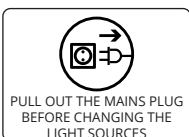
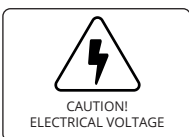

■ **Initial operation**

1. Remove packaging material
2. Insert G9 light source
3. Connect the cable to the socket
4. Switching on and off with pull switch

Slight leaning of the lampshade can be remedied by carefully bending the wire frame.

■ **Changing the light source**

Attention, important note:

For all work on the lamp, always disconnect the mains plug first! In case of a G9 high-voltage halogen lamp, let the lamp cool down!

1. Press the screen basket down from above
2. Remove the defective lamp and insert the new lamp. Let the lampshade basket slowly escape upwards under its own power.

When using a high-voltage lamp of type G9, maximum power 40W!

There is no limit for LED light sources.

■ **Insert G9 light source**



■ **Change light source G9**

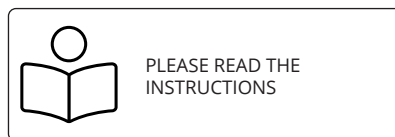



Installation instructions

Replacing the pull cord for E27 lampholder with integrated switch

SAFETY

All electrical work (work on electrical equipment and installations) must be carried out and inspected by a qualified electrician or under their direction and supervision!

For all work on the lamp, always disconnect it from the mains first (pull the plug out of the socket).

Step 1: Remove the shade

- Unscrew the glass or fabric shade from the socket (unscrew the shade basket, light source and socket ring first).

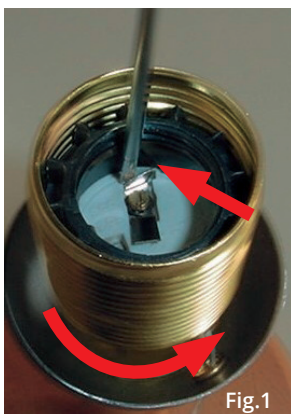

Step 2: Unscrew the socket housing - Fig.1

- Press the metal lug inwards with a screwdriver and unscrew the housing to the left.

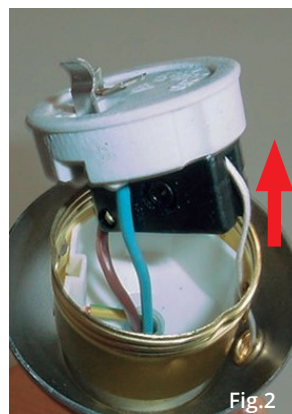

Step 3: Pull out the contact stone upwards - Fig.2

- Check that the connected cables are.

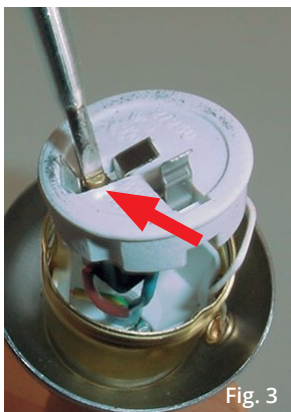

Step 4: Unscrew pull switch - Fig.3

- Loosen the screw of the switch on the contact stone (ceramic part) and pull the switch downwards. Unscrew the brown wire from the switch.

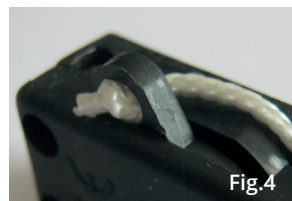

Step 5: Pull the pull cord into the switch - Fig.4+5

- First remove the broken pull cord and pull in the new one. Tie a knot after the pull-cord eyelet and cut off the excess cord to approx. 3 mm.



Take the switch in your hand and test it by pulling the cord. Refit the switch to the contact stone and insert it into the lower part of the lampholder.

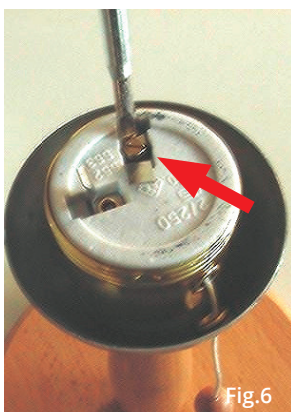

Step 6: Fig.6

- Push the metal nose from step 2 outwards again. Screw on the socket housing and make sure that it engages with the metal lug. Check that it is firmly seated by turning it back slightly. Pull pull cord through lamination hole and reattach pull cord handle (ball or spring). Length of

protruding cord as desired between 80 and 120 mm.

Installation of shade in reverse order.

Order.-No.: 730259
Short-Desc.: LA-ZUG-KIT